

row: 1, col: 1

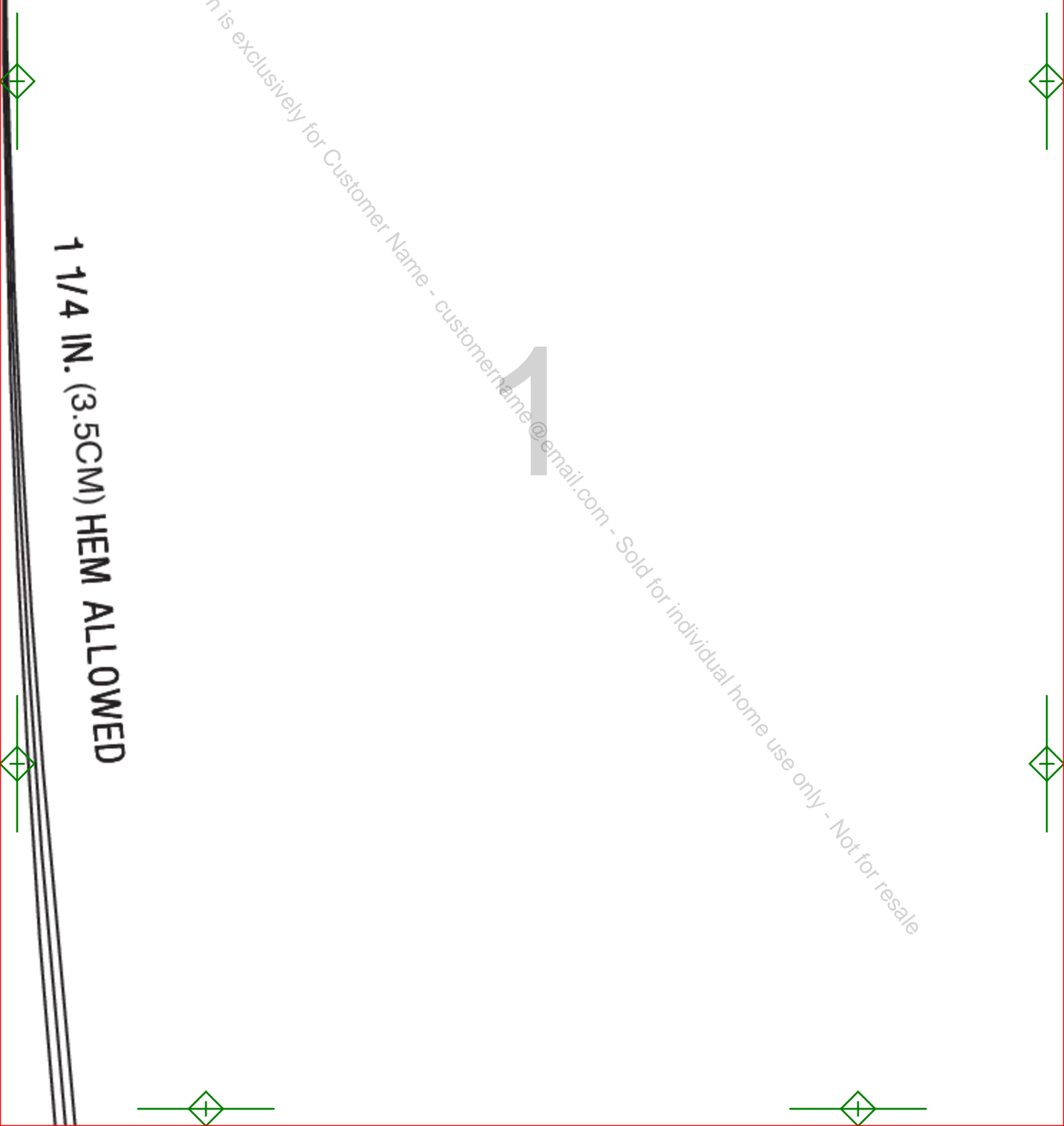

This pattern is exclusively for Customer Name - customername@email.com - Sold for individual home use only - Not for resale

**1 1/4 IN. (3.5CM) HEM ALLOWED**



This pattern is exclusively for Customer Name - customername@email.com - Sold for individual home use only - Not for resale

WAISTLINE

CASING LINE



CENTER FOLD

This pattern is exclusively for Customer Name - customername@email.com - Sold for individual home use only - Not for resale

Miss size A(S-M-L)

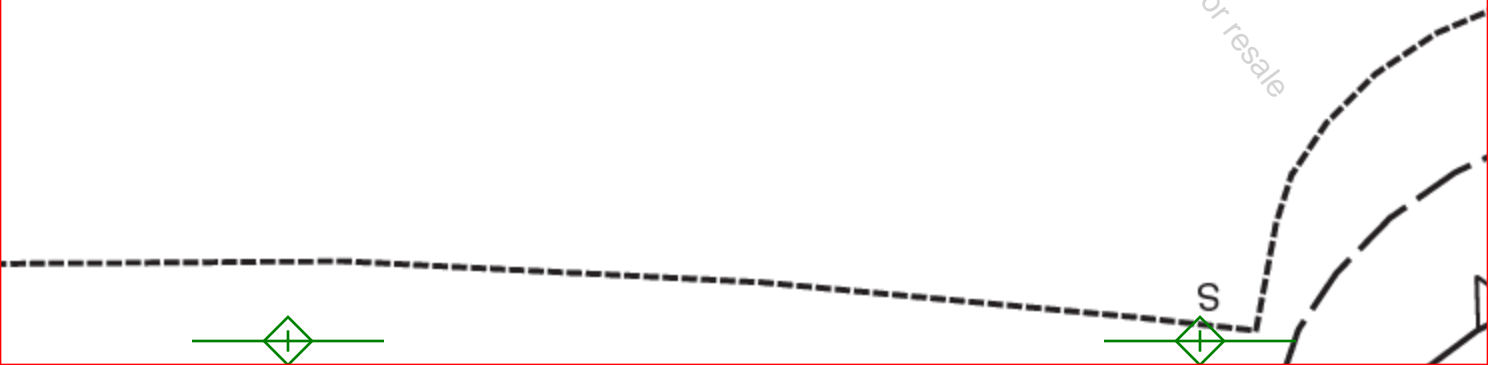



3/8 IN. (1cm) SEAM ALLOWANCE

54

BACK

CUT 1 ON FOLD

McCall's  
M8172

This pattern is exclusively for Customer Name - Customername@email.com - Sold for individual home use only - Not for resale

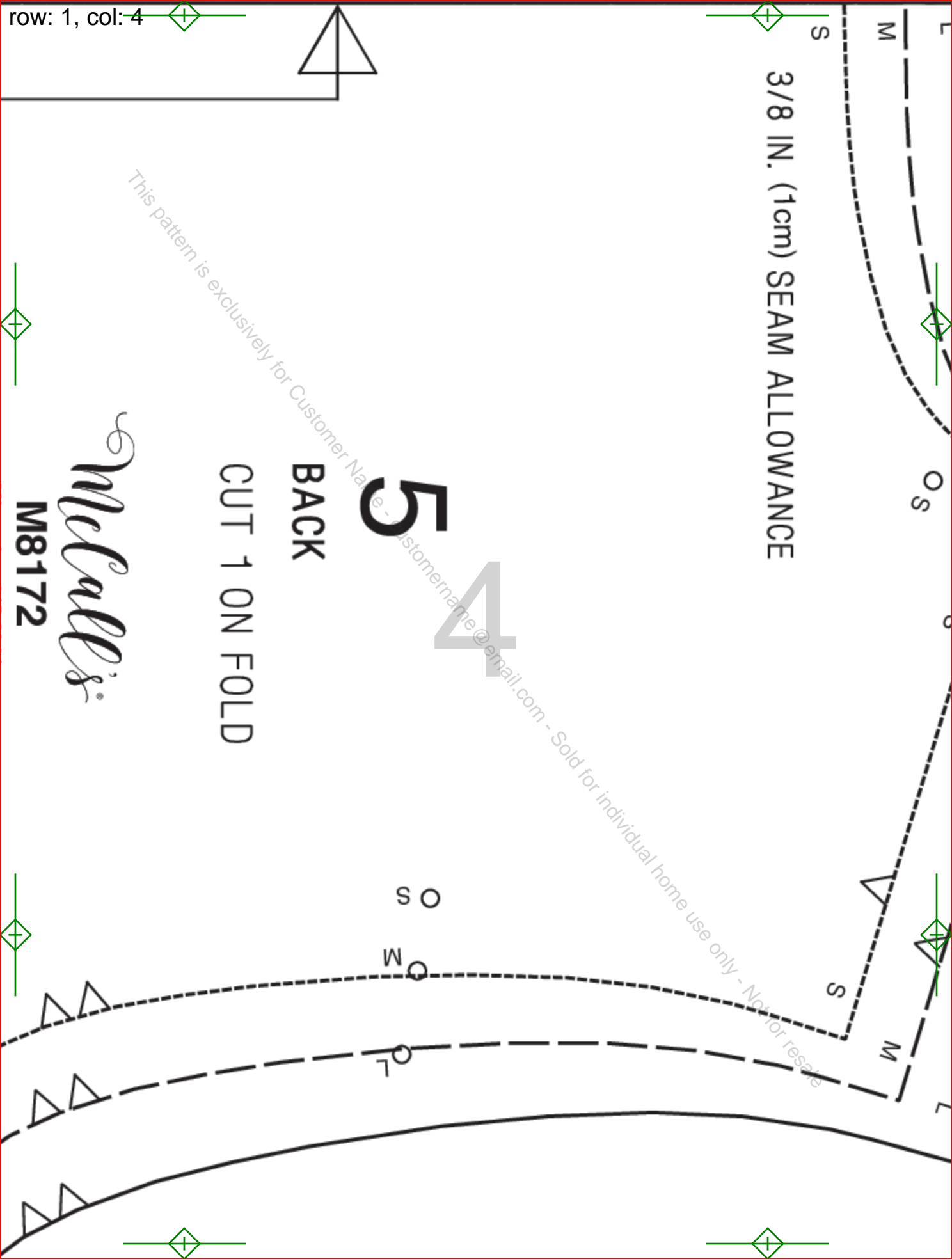

This pattern is exclusively for Customer Name - customername@email.com - Sold for individual home use only - Not for resale

5

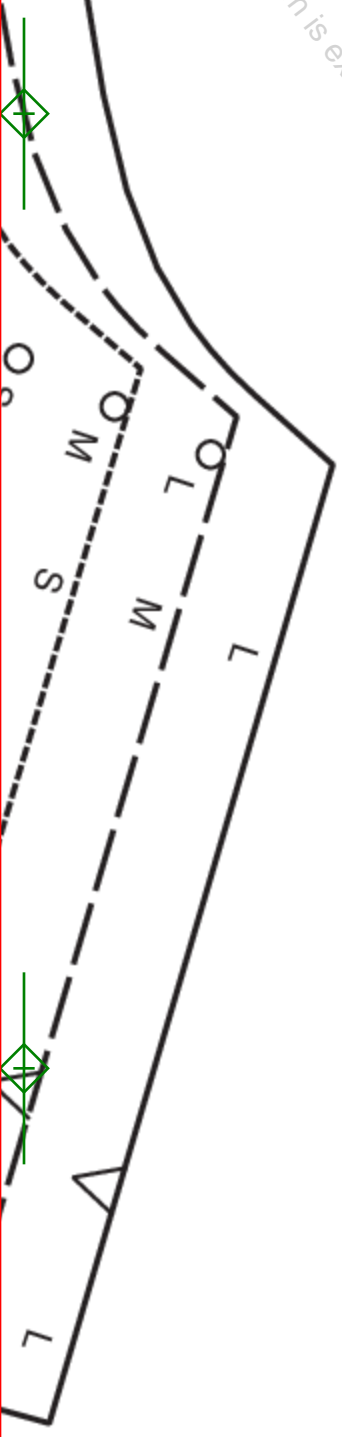

This pattern is exclusively for Customer Name - customername@email.com - Sold for individual home use only - Not for resale

S

M

L

L

M

S

OL

OM

OS

2

NECK BAND

CUT 2

McCall's

L

M

S

L

M

S

OWED

This pattern is exclusively for Customer Name - customername@email.com - Sold for individual home use only - Not for resale

STRETCH

7

M8172

Miss size A(S-M-L)

STRETCH

1 1/4 IN. (3.5CM) HEM ALLOW



row: 2, col: 3



This pattern is exclusively for Customer Name - customername@email.com - Sold for individual home use only - Not for resale

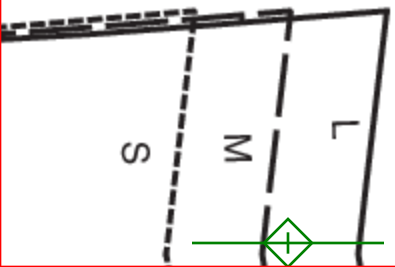

This pattern is exclusively for Customer Name - customername@email.com

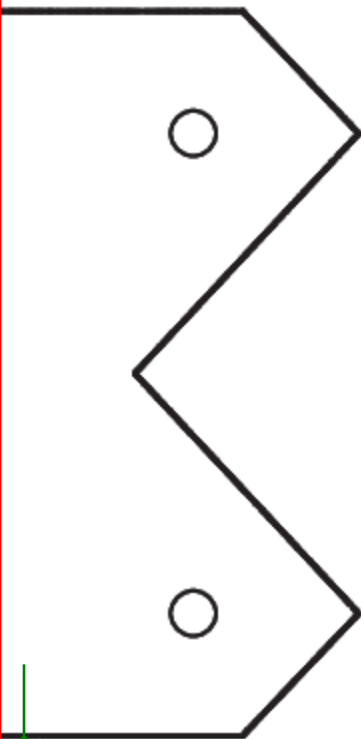

FOLD LINE

4

POCKET  
CUT 1

*McCall's*

**M8172**

Miss size A(S-M-L)



Sold for individual home use only - Not for resale

This pattern is exclusively for Customer Name - customername@email.com - Sold for individual home use only - Not for resale

10



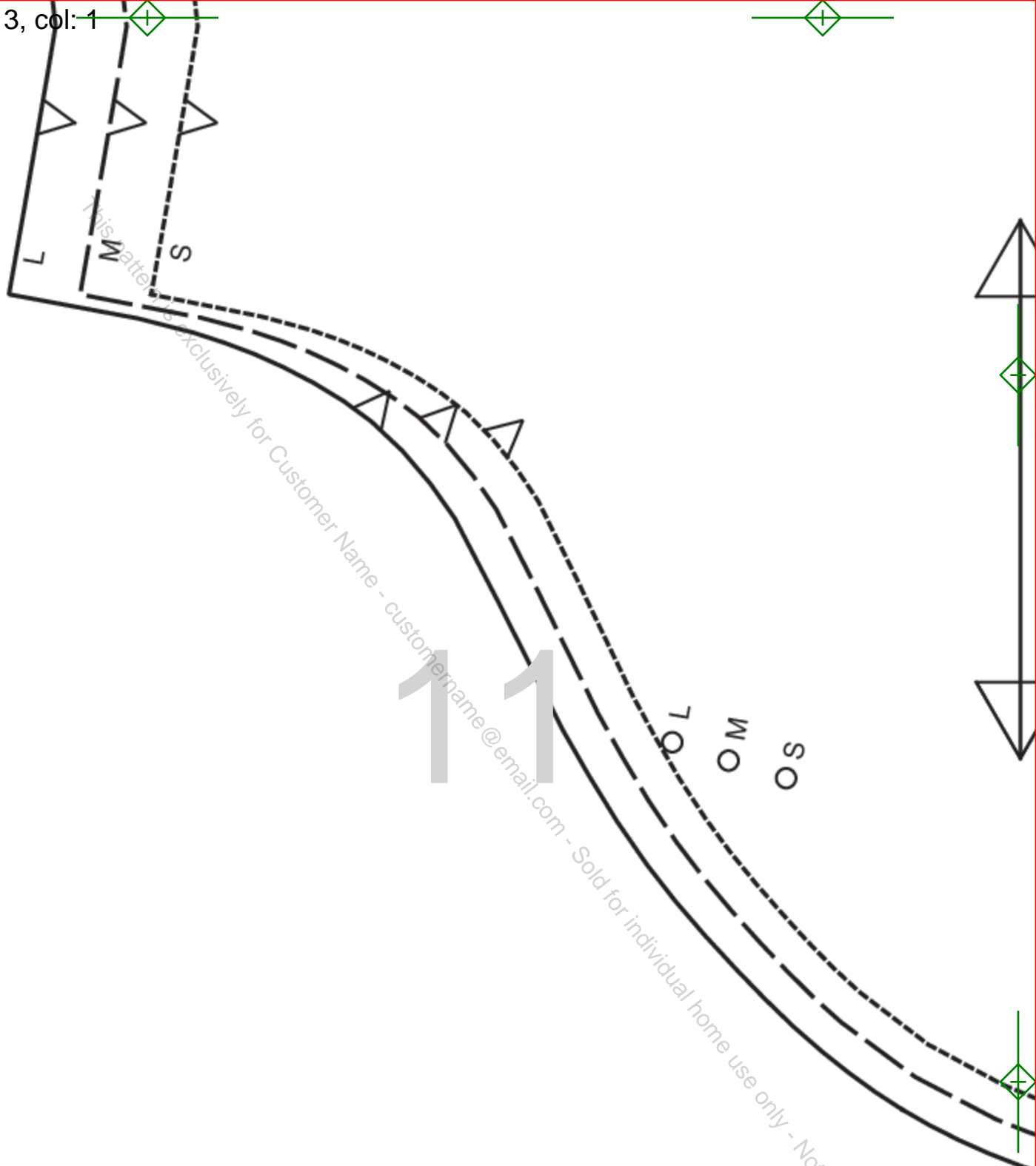

Miss size A(S-M-L)

M8172

*Micas*

SLEEVE  
CUT 2

9

12

EASE

LO  
MO  
SO

LO  
MO  
SO

Not for individual home use only - Not for resale



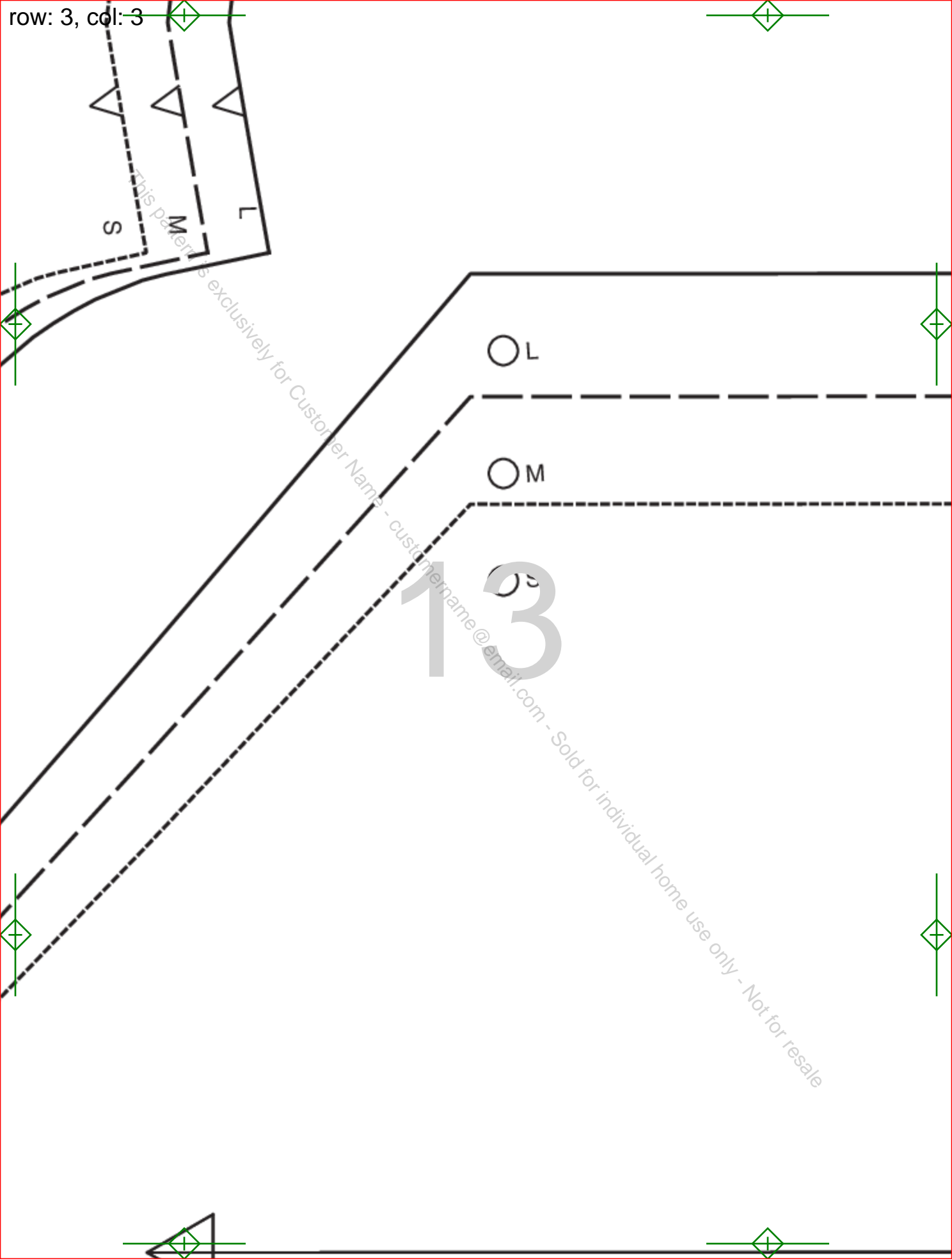

S  
M  
L

OL

OM

13

This pattern is exclusively for Customer Name - customername@email.com - Sold for individual home use only - Not for resale

This pattern is exclusively for Customer Name - customername@email.com - Sold for individual home use only - Not for resale

L

M

S

5/8 IN. (1.5cm) HEM ALLOWED

14



This pattern is exclusively for Customer Name - customername@email.com

15

**3**  
**FRONT TIE END**  
**CUT 2**

*McCa*  
**M817**  
Miss size A

Sold for individual home use only - Not for resale



This pattern is exclusively for Customer Name - customername@email.com

16

1

FRONT  
CUT 2

McCall's

M8172

Miss Size A (S-M-L)

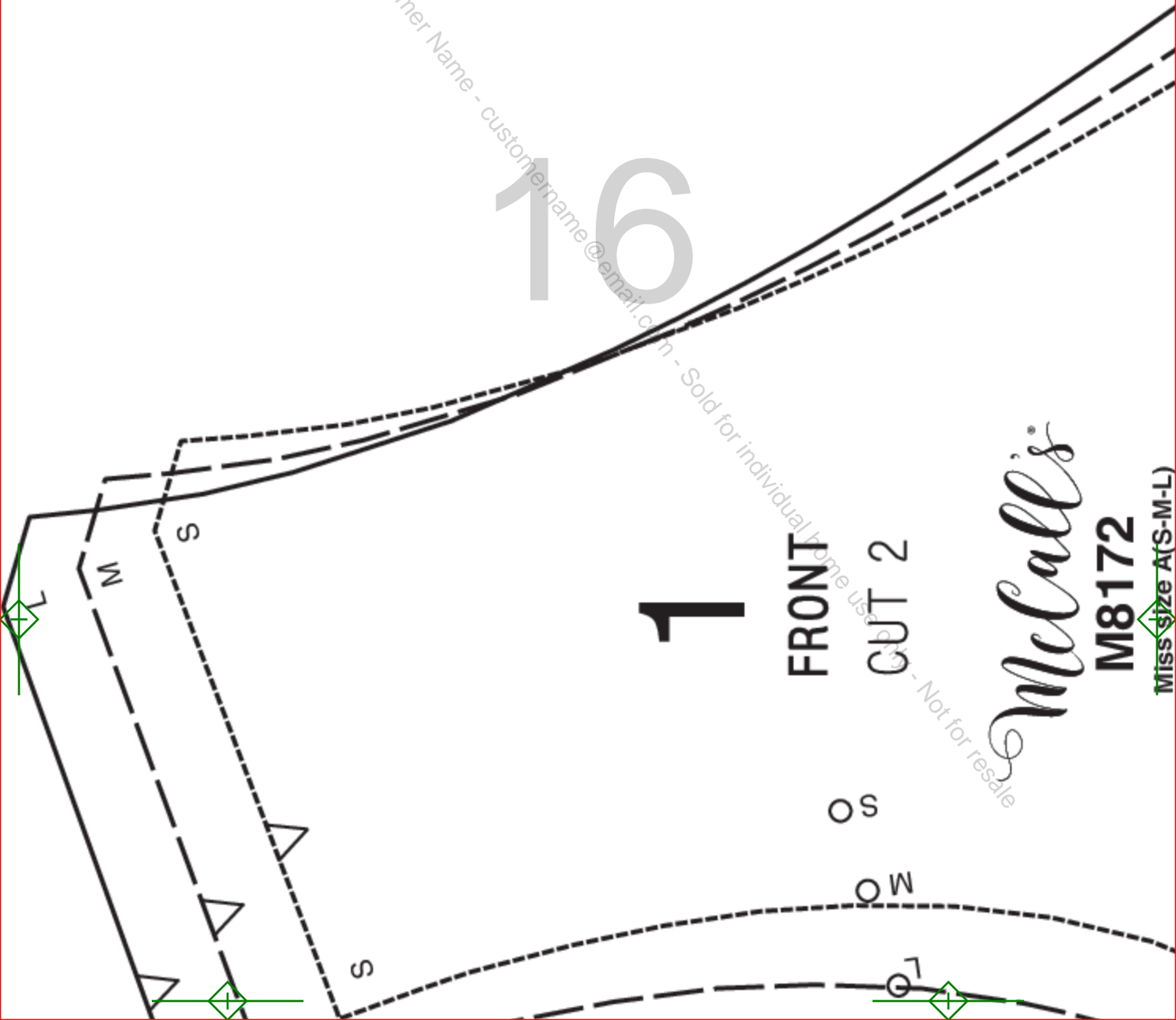

OS

MO

G1

- Sold for individual home use only - Not for resale

This pattern is exclusively for Customer Name - customername@email.com - Sold for individual home use only - Not for resale

CENTER FRONT

17

Miss Size A(S-M-L)

© 2020 a CSS Industries, Inc. brand  
All Rights Reserved  
Printed in U.S.A.

MENT MEASUREMENTS  
(96.5 CM)  
" (106CM)  
" (116 CM)

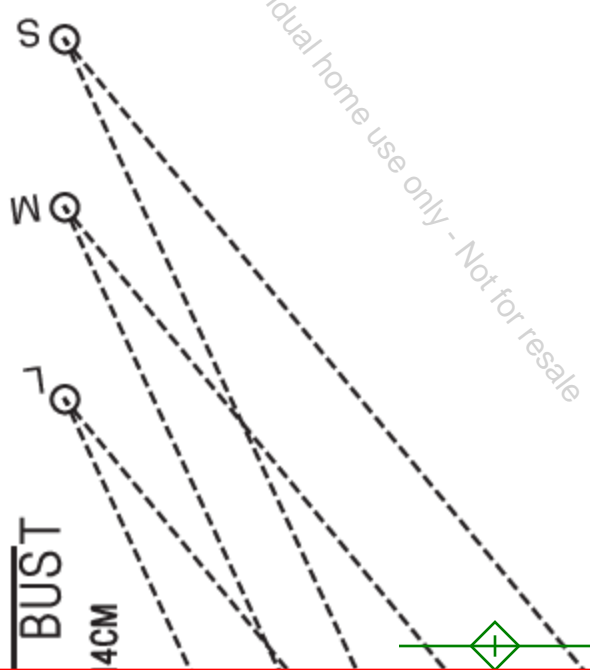

BUST  
4CM

This pattern is exclusively for Customer Name - customername@email.com - Sold for individual home use only - Not for resale

WAISTLINE

18



This pattern is exclusively for Customer Name - customername@gmail.com - Sold for individual home use only - Not for resale

19

S

POCKET LINE RIGHT SIDE ONLY

M

POCKET LINE RIGHT SIDE ONLY

L

POCKET LINE RIGHT SIDE ONLY

S

POCKET LINE RIGHT SIDE ONLY

1 1/4 IN. (3.5CM) HEM ALLOWED

Pattern is exclusively for Customer Name - customername@email.com - Sold for individual home use only - Not for resale

172

Calli's



20

Pattern is exclusively for Customer Name - customername@email.com - Sold for individual home use only - Not for resale

This pattern is exclusively for Customer Name - customername@email.com - Sold for individual home use only - Not for resale

21



FINISHED GARMENT  
S 38"  
M 41 1/2"  
L 45 1/2"

\* TOTAL EASE ABOVE  
BODY MEASUREMENT IS  
APPROXIMATELY: 5 1/2" 14C

The pattern is exclusively for Customer Name - customername@email.com

22

Sold for individual home use only - Not for resale

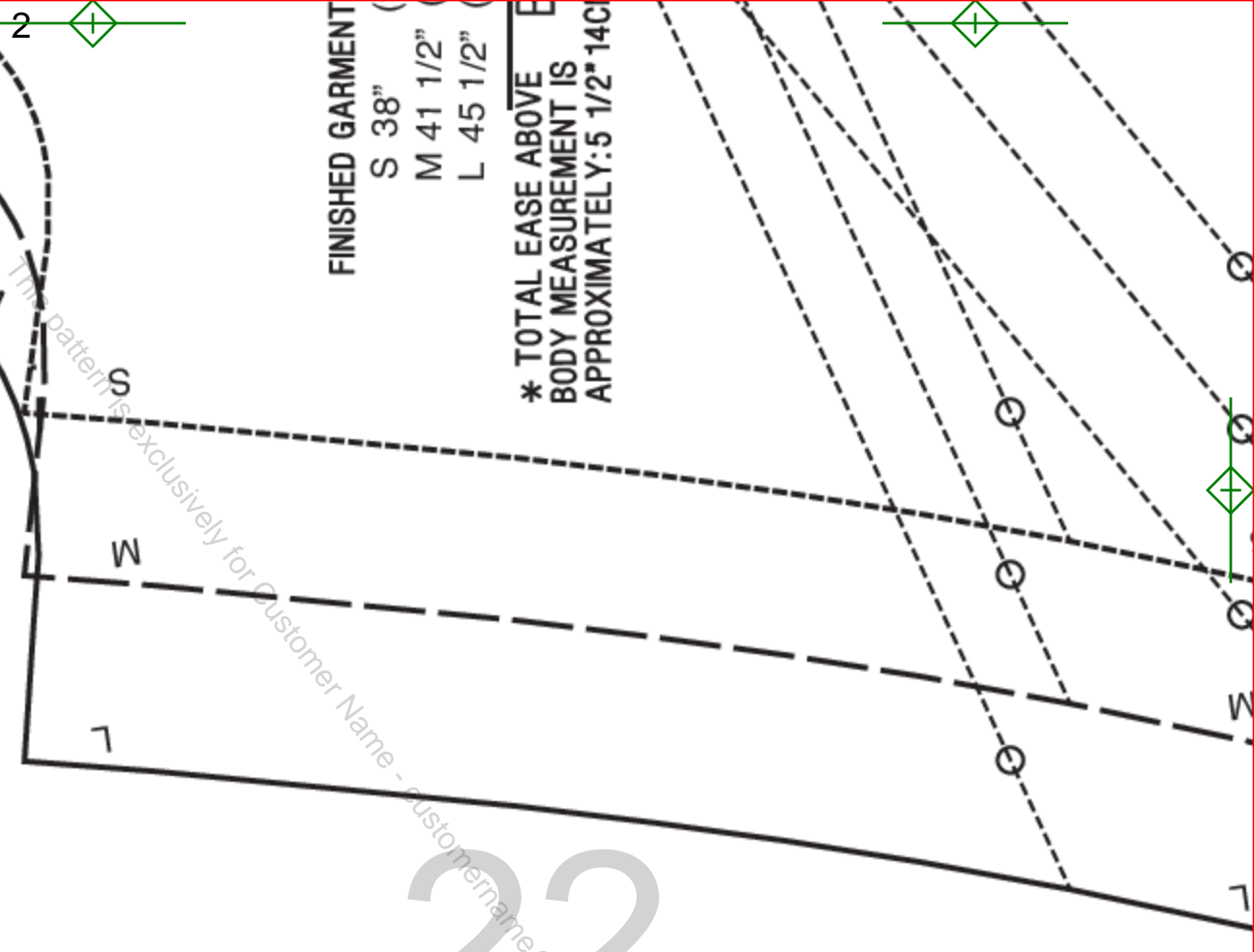

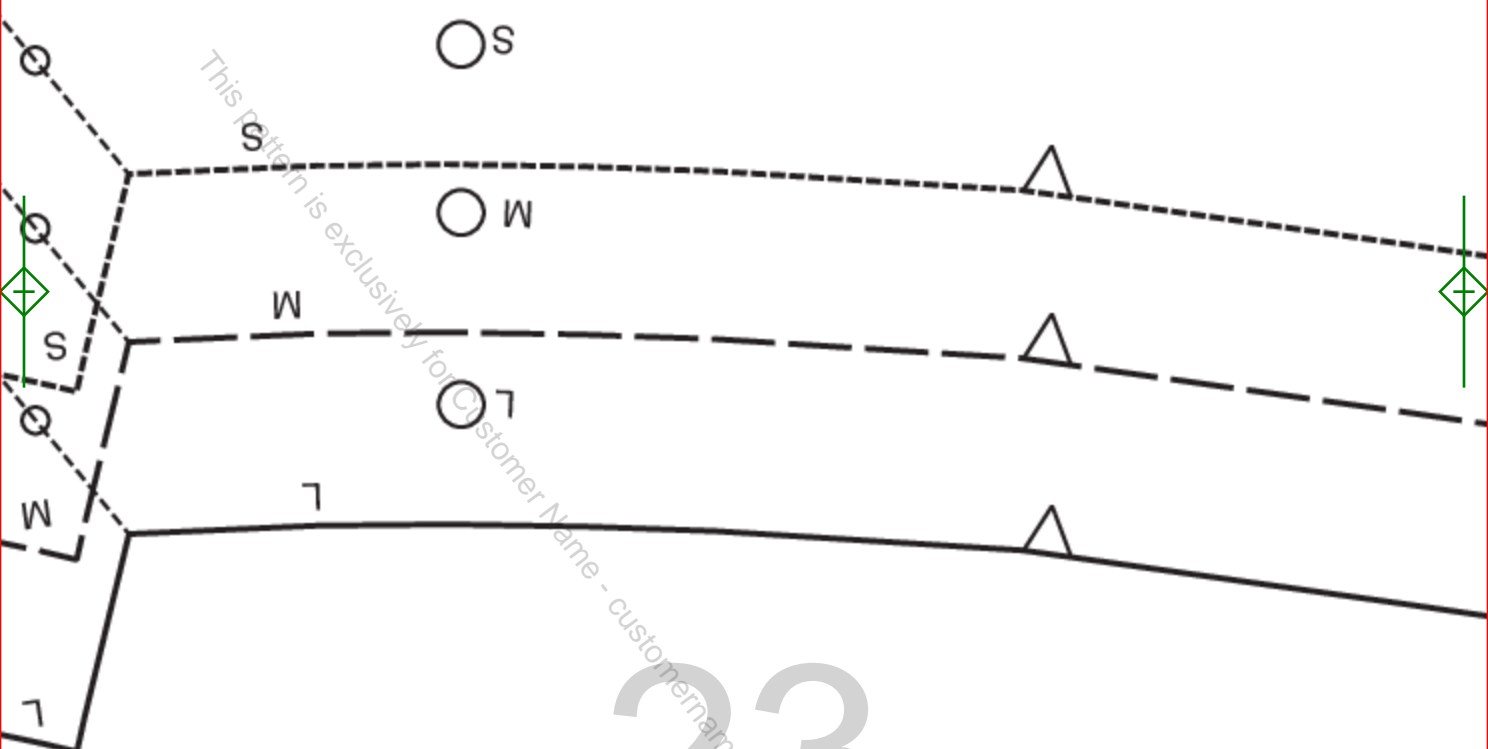

This pattern is exclusively for  Customer Name - customername@email.com - Sold for individual home use only - Not for resale

23

Sold for individual home use only - Not for resale



POCKET LINE RIGHT SIDE ONLY

M

POCKET LINE RIGHT SIDE ONLY

L

POCKET LINE RIGHT SIDE ONLY

This pattern is exclusively for Customer Name - customer.name@email.com - Sold for individual home use only - Not for resale

24

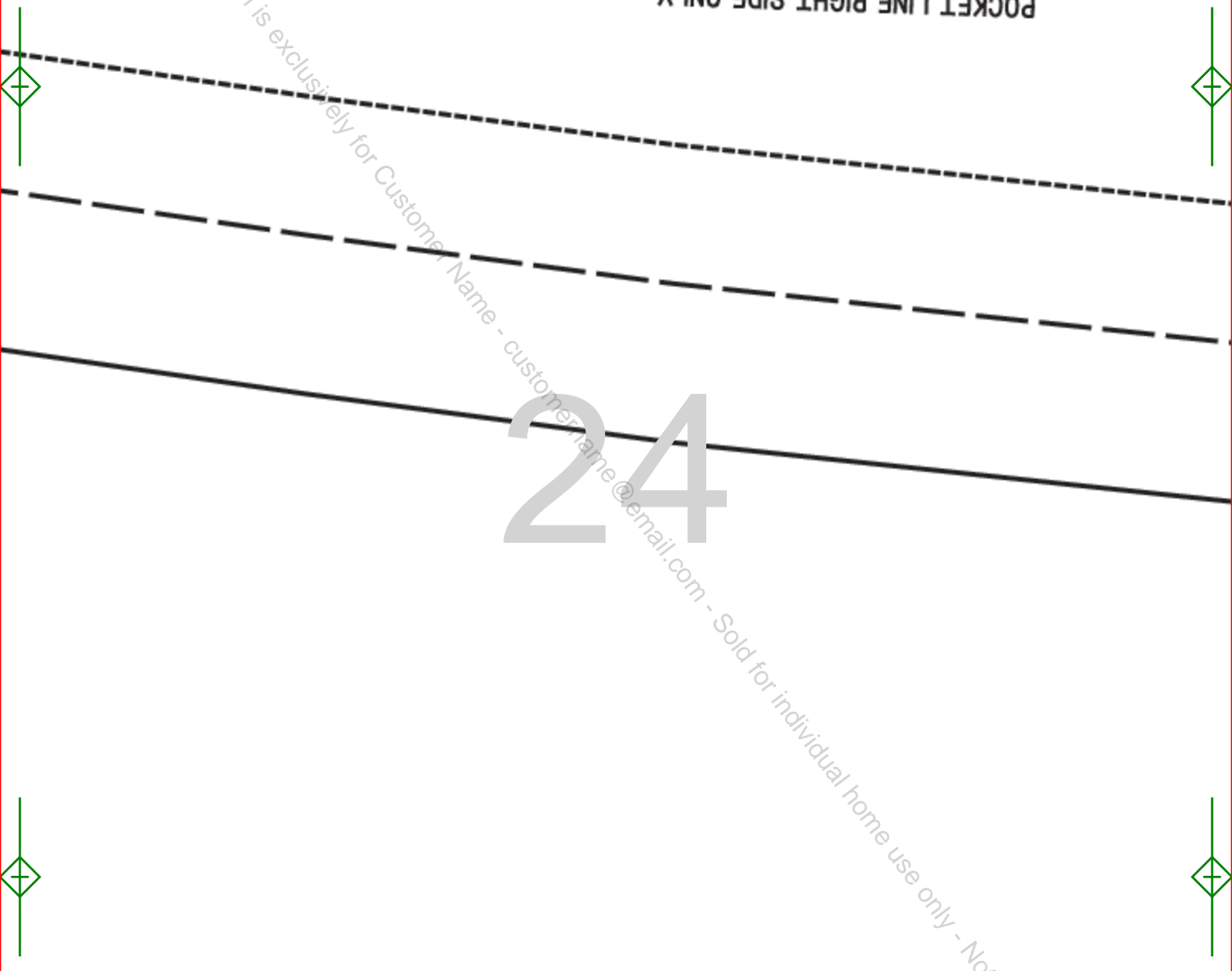

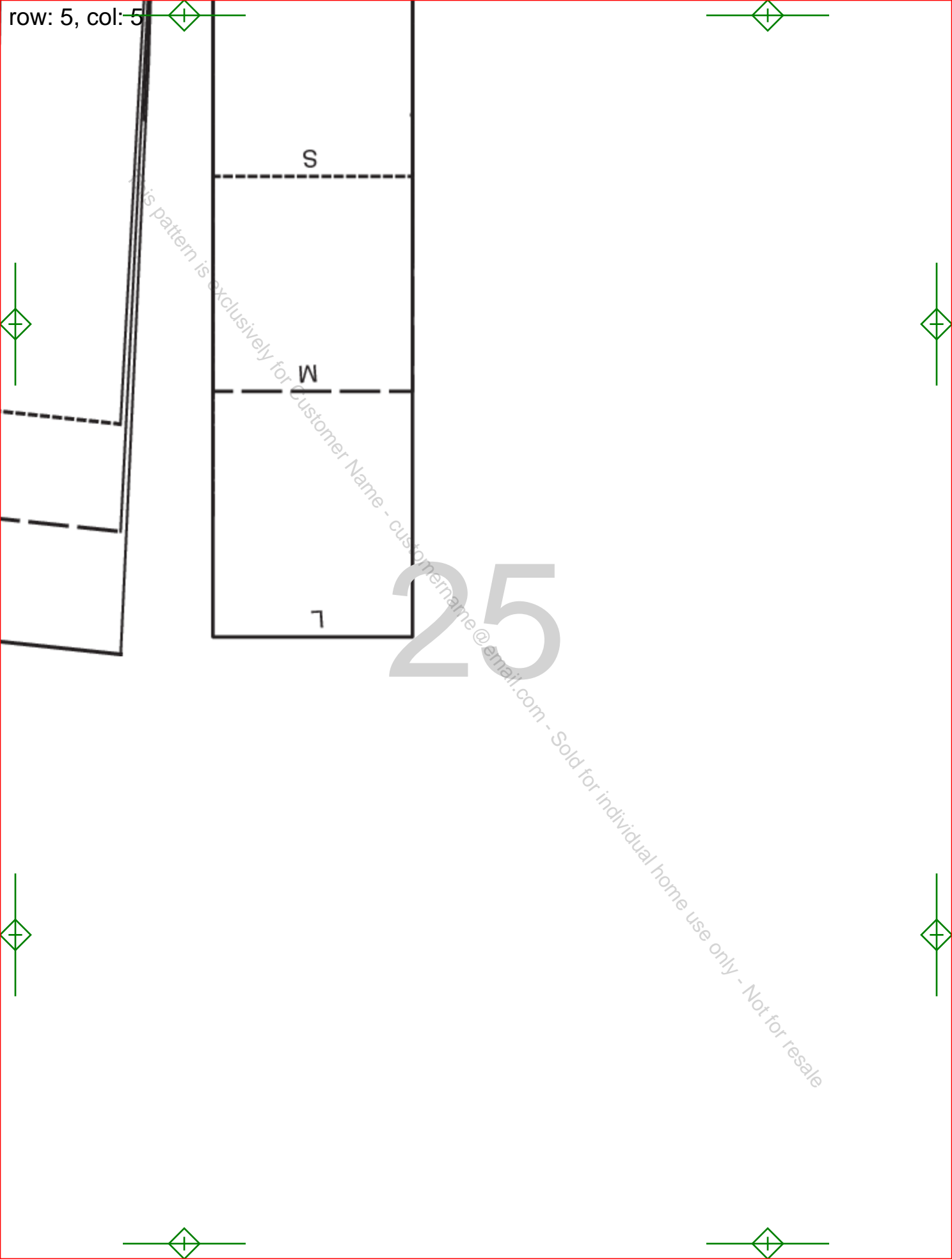

This pattern is exclusively for Customer Name - customername@email.com - Sold for individual home use only - Not for resale

25

S

W

7